

# DMC X SEWBEEIT - SPRING DMC X SEWBEEIT - PRINTEMPS

COLOUR GUIDE / DIAGRAMME EN COULEUR

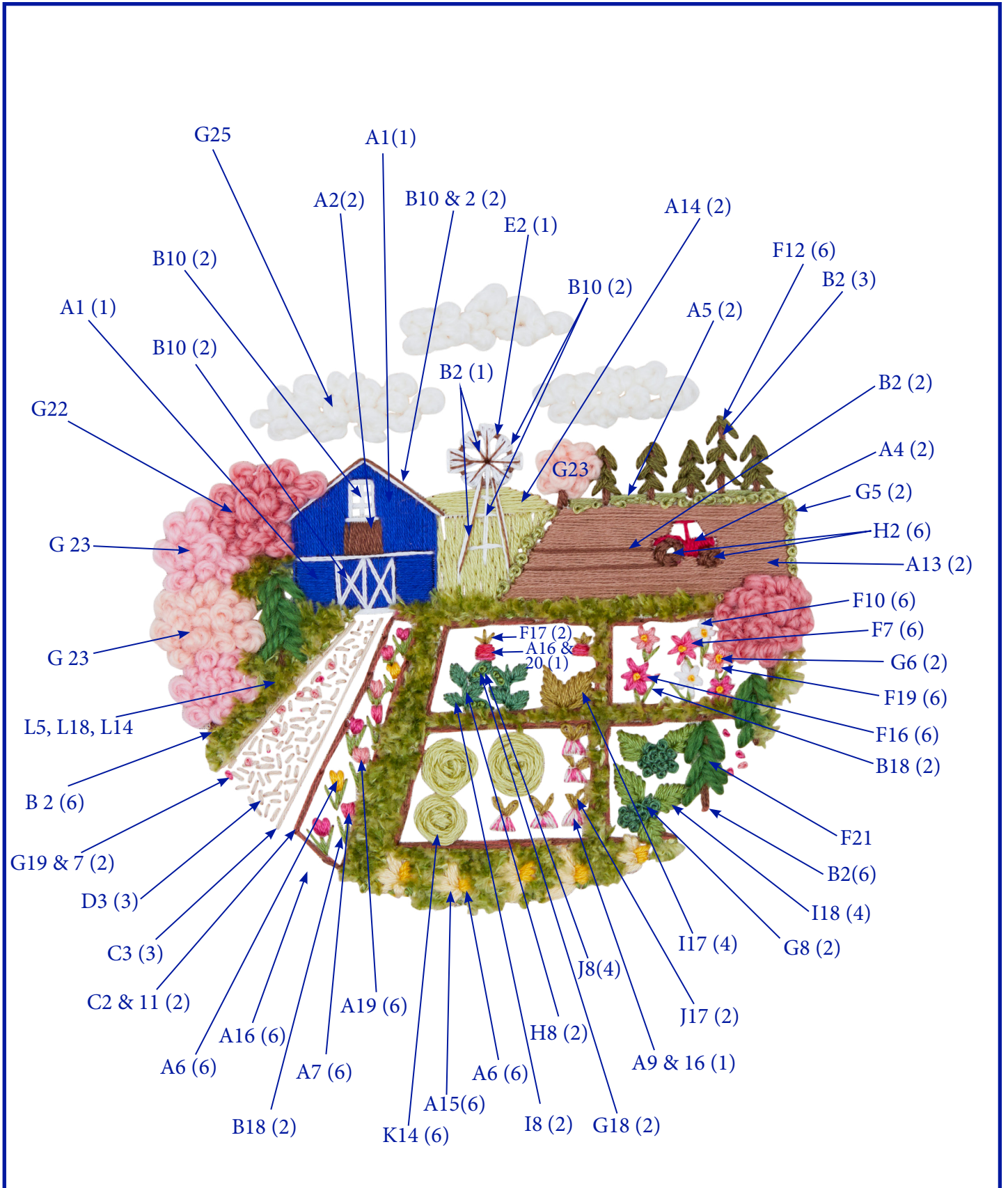

WWW.DMC.COM © 2023 / ALL RIGHTS RESERVED WORLDWIDE

DMC LIBRARY - BIBLIOTHÈQUE DMC

# DMC X SEWBEEIT - SPRING DMC X SEWBEEIT - PRINTEMPS

TECHNICAL CHART / DIAGRAMME



# DMC X SEWBEEIT - SPRING

## DMC X SEWBEEIT - PRINTEMPS

### INSTRUCTIONS

#### TOOL KIT / FOURNITURES

























NEEDLE / AIGUILLE

DMC MOULINÉ SPÉCIAL STRANDED COTTON ART 117

DMC COLBERT WOOL

MAGIC SHEET OR TRANSFER PEN / FEUILLE MAGIQUE OU STYLO TRANSFERT

#### COLOUR / COULEURS

CODE N° CODE N°	COLOUR COULEUR	N° SKEINS(1) N° D'ÉCHEVETTES(1)	THREAD TYPE TYPE DE FIL	CODE N° CODE N°	COLOUR COULEUR	N° SKEINS(1) N° D'ÉCHEVETTES(1)	THREAD TYPE TYPE DE FIL
1	 796	x 1	Mouliné Spécial	14	 3348	x 1	Mouliné Spécial
2	 839	x 1	Mouliné Spécial	15	 677	x 1	Mouliné Spécial
3	 842	x 1	Mouliné Spécial	16	 3805	x 1	Mouliné Spécial
4	 304	x 1	Mouliné Spécial	17	 3012	x 1	Mouliné Spécial
5	 3364	x 1	Mouliné Spécial	18	 3347	x 1	Mouliné Spécial
6	 728	x 1	Mouliné Spécial	19	 760	x 1	Mouliné Spécial
7	 602	x 1	Mouliné Spécial	20	 347	x 1	Mouliné Spécial
8	 367	x 1	Mouliné Spécial	21	 7043	x 1	Colbert Wool
9	 Ecrû	x 1	Mouliné Spécial	22	 7760	x 1	Colbert Wool
10	 Blanc	x 1	Mouliné Spécial	23	 7133	x 1	Colbert Wool
11	 632	x 1	Mouliné Spécial	24	 7853	x 1	Colbert Wool
12	 936	x 1	Mouliné Spécial	25	 Ecrû	x 1	Colbert Wool
13	 840	x 1	Mouliné Spécial				

#### NUMBER OF STRANDS / NOMBRE DE BRINS

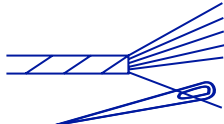
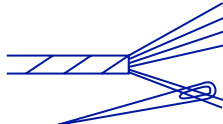
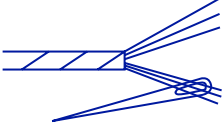
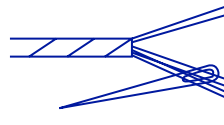
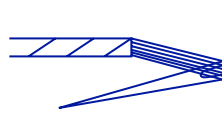
<p>USE 1 THREAD UTILISER 1 FIL</p> 	<p>USE 1 STRANDS UTILISER 1 BRINS</p> <p>(1)</p> 	<p>USE 2 STRANDS UTILISER 2 BRINS</p> <p>(2)</p> 
<p>USE 3 STRANDS UTILISER 3 BRINS</p> <p>(3)</p> 	<p>USE 4 STRANDS UTILISER 4 BRINS</p> <p>(4)</p> 	<p>USE 6 STRANDS UTILISER 6 BRINS</p> <p>(6)</p> 

\*Number of strands and skeins calculated for design size 12.5cm x 12.5cm  
Nombre de brins et d'échevettes calculé pour un dessin de 12.5cm x 12.5cm

# DMC X SEWBEEIT - SPRING

# DMC X SEWBEEIT - PRINTEMPS

## INSTRUCTIONS

### STITCHES / POINTS

CODE LETTER  
LETTRE

**A**



Satin stitch / Passé plat

CODE LETTER  
LETTRE

**B**

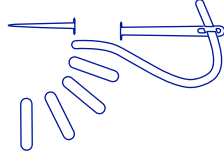

Straight stitch / Point lancé

CODE LETTER  
LETTRE

**C**

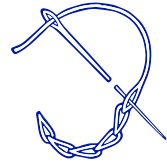

Split stitch / Point fendu

CODE LETTER  
LETTRE

**D**

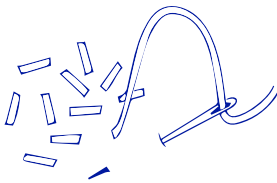

Seed stitch / Point semé

CODE LETTER  
LETTRE

**E**

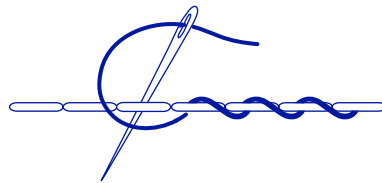

Whipped backstitch / Point de piqûre surjeté

CODE LETTER  
LETTRE

**F**



Backstitch / Point arrière

CODE LETTER  
LETTRE

**G**

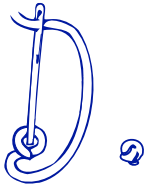

French knot / Point de noeud

CODE LETTER  
LETTRE

**H**

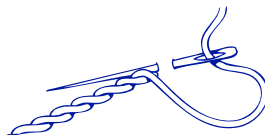

Stem stitch / Point de tige

CODE LETTER  
LETTRE

**I**



Fishbone stitch / Point d'arête

CODE LETTER  
LETTRE

**J**

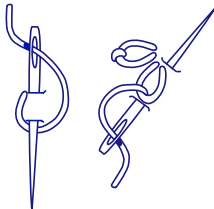

Lazy daizy stitch / Point de bouclette

CODE LETTER  
LETTRE

**K**

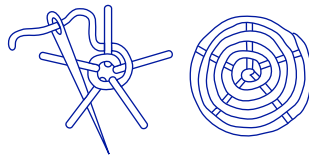

Woven wheel stitch / Point de roue tissé

CODE LETTER  
LETTRE

**L**

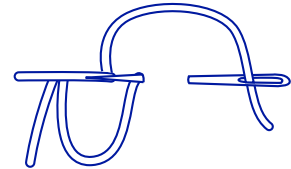

Turkey Rug Stitch / Point de tapisserie turque

# INSTRUCTIONS

## TRANSFER PEN / STYLO TRANSFER

STEP  
ÉTAPE

1

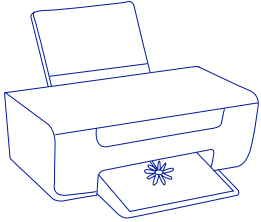

Download your design sheet, print it out. The design format is A4 so if you are printing on US letter, make sure to print at 100%.

Téléchargez votre feuille de motif et imprimez-la. Le format de la feuille est en format A4. Si vous imprimez au format US Letter, assurez-vous d'imprimer à 100%.

STEP  
ÉTAPE

2

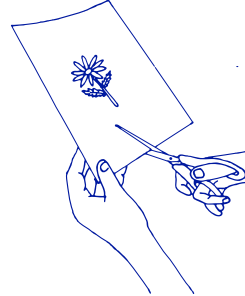

Cut around the illustrations from the printed sheet and place the design you want to stitch, face side up, on a flat surface. NB: if you don't place the design face side up your design will be Fwards.

Découpez le motif que vous souhaitez broder et placez-le du bon côté vers le haut, sur une surface plane. NB: si vous ne le placez pas du bon côté vers le haut.

STEP  
ÉTAPE

3

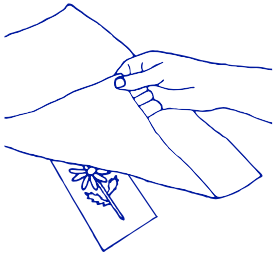

Decide where you want your embroidery and place your base fabric on top of your design sheet and secure it using pins or masking tape.

Choisissez le tissu sur lequel vous souhaitez broder votre motif et placez-le sur le motif. Puis, sécurisez le motif sur le tissu à l'aide d'épingles ou d'un ruban adhésif.

STEP  
ÉTAPE

4



Place your base fabric against an available light source i.e a window, lightbox or computer screen and trace the design onto your base fabric using a water soluble embroidery transfer pen.

Placez votre tissu contre une source lumineuse - une fenêtre, une table lumineuse ou un écran d'ordinateur et décalquez votre motif sur le tissu avec un stylo de transfert soluble à l'eau.

STEP  
ÉTAPE

5

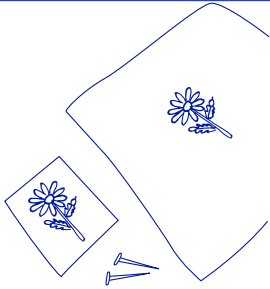

Once you have traced the design, remove the pinned design from the F of your fabric.

Une fois votre motif transféré sur le tissu, enlevez le motif épinglé à l'arrière du tissu.

STEP  
ÉTAPE

6



Hoop fabric and start stitching out your design following the stitch instruction illustrations. It's super easy, just follow the lines.

Commencez à broder votre conception en suivant les lignes du motif que vous venez de tracer.

STEP  
ÉTAPE

7

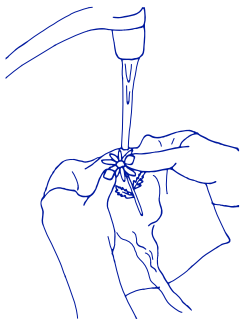

Once you have finished stitching your design, rinse your base fabric in cold water to remove transfer pen ink.

Quand vous avez fini de broder votre motif, rincez le tissu à l'eau froide pour dissoudre l'encre du stylo de transfert.

STEP  
ÉTAPE

8

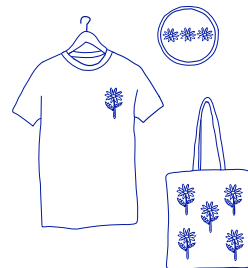

Enjoy your custom embroidered creation.

Profitez de votre création!

# INSTRUCTIONS

## MAGIC PAPER / FEUILLE MAGIQUE

STEP  
ÉTAPE

1

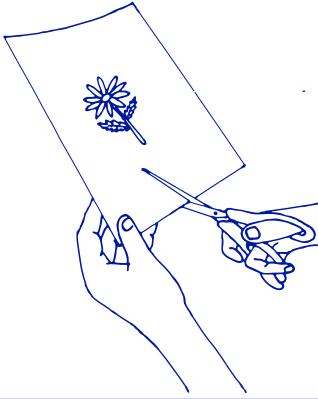

Download and print your pattern. Trace the printed design onto the plain Magic Paper before cutting it out.

Téléchargez et imprimez votre diagramme. Dupliquez le motif imprimé sur le papier magique avant de le découper.

STEP  
ÉTAPE

2

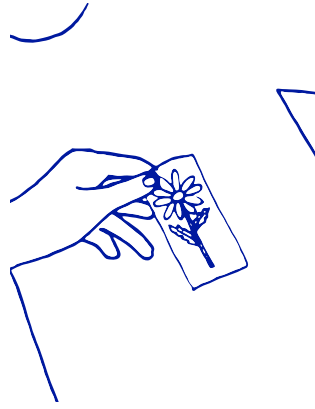

Lay your base fabric on a flat surface and place your design in the desired position. Don't be afraid to play around with the positioning, be creative!

Posez votre tissu de base sur une surface plane et placez votre motif dans la position désirée. N'ayez pas peur de jouer avec le positionnement, soyez créatif!

STEP  
ÉTAPE

3



When you are happy with the position, peel away the paper Film and stick your design onto your base fabric.

Lorsque vous êtes satisfait du positionnement, décollez le film protecteur et collez votre design sur le tissu.

STEP  
ÉTAPE

4

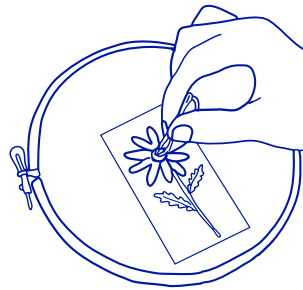

Hoop fabric and start stitching out your design following the stitch instruction illustrations. It's super easy, just follow the lines.

Commencez à broder votre motif en suivant les illustrations. C'est super facile, il suffit de suivre les lignes.

STEP  
ÉTAPE

5

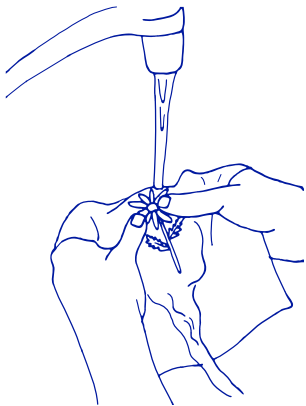

Once you have finished stitching your design, rinse your base fabric in cold water to dissolve the magic paper template and let it dry.

Une fois fini, rincez le tissu à l'eau froide pour dissoudre le papier magique, et laissez sécher.

STEP  
ÉTAPE

6

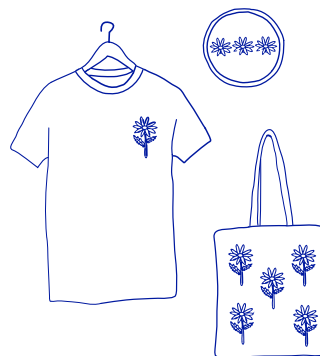

Enjoy your custom embroidered creation.

Profitez de votre création!