

WEIGHTLIFTING HALTÉROPHILIE

COLOURED TAPESTRY CHART
DIAGRAMME TAPISSERIE EN COULEURS

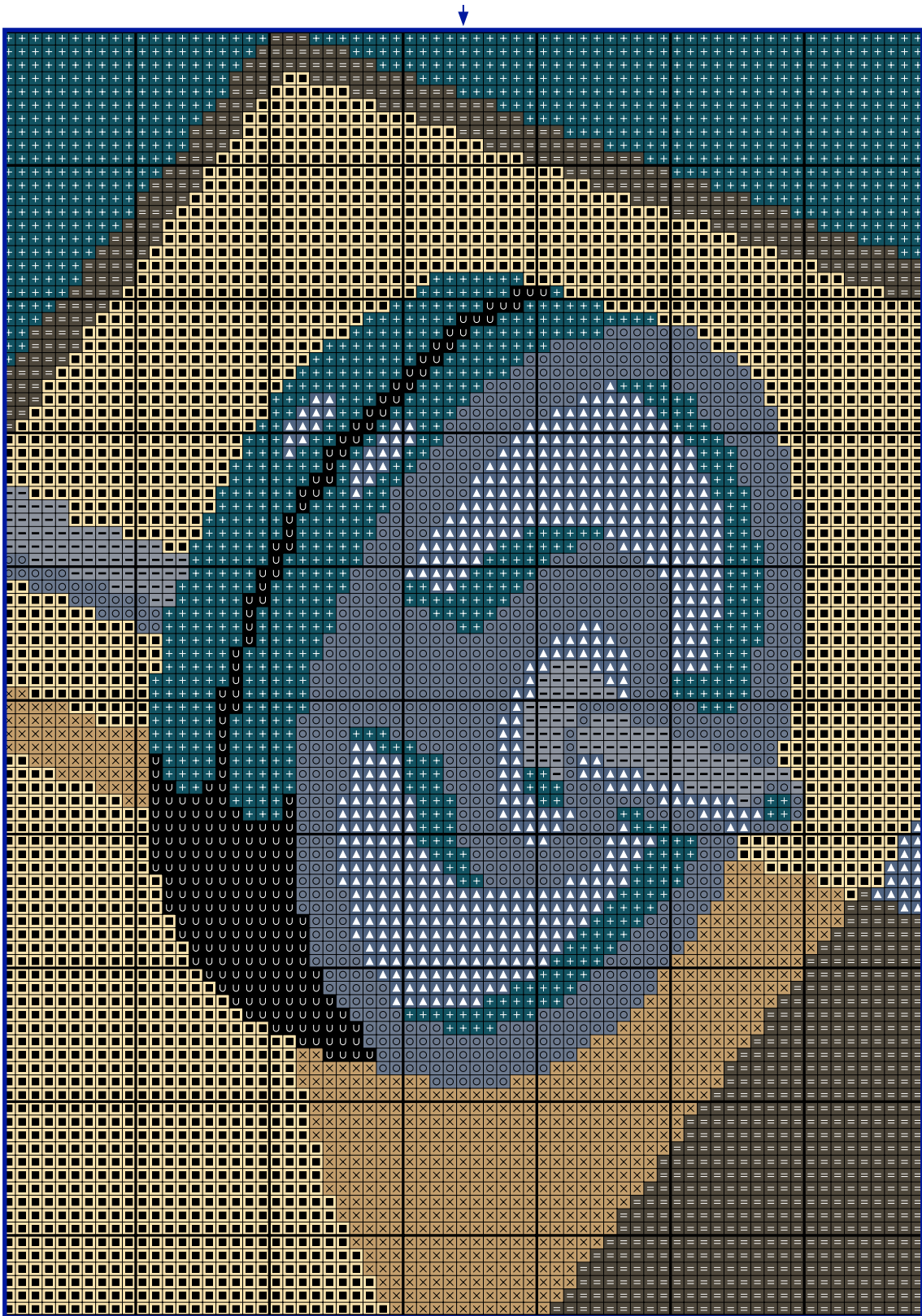

WEIGHTLIFTING HALTÉROPHILIE

TAPESTRY CHART
DIAGRAMME TAPISSERIE

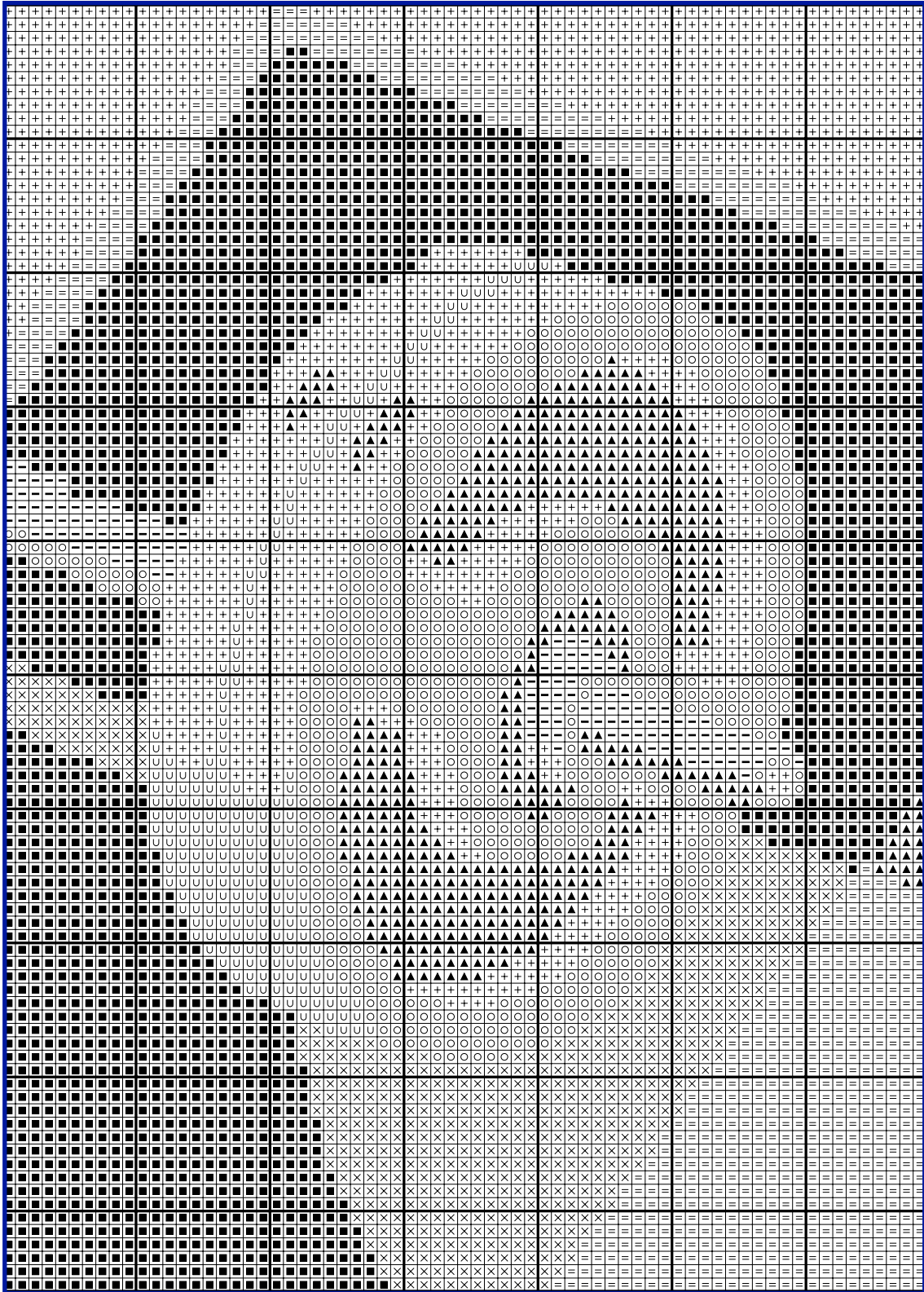

WEIGHTLIFTING HALTÉROPHILIE

TAPESTRY CHART
DIAGRAMME TAPISSERIE

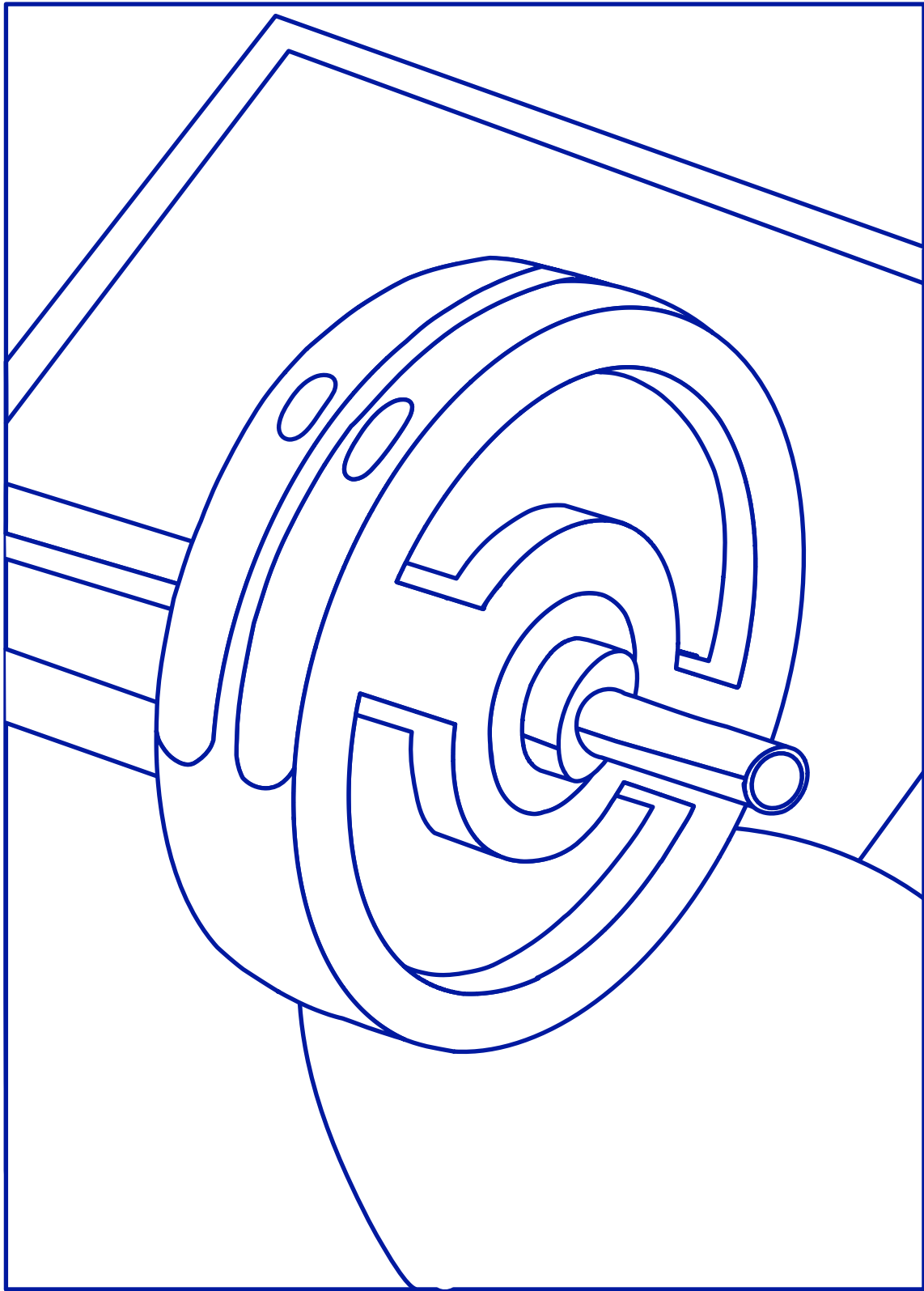

© 2024 / ALL RIGHTS RESERVED WORLDWIDE

DMC LIBRARY - BIBLIOTHÈQUE DMC

WEIGHTLIFTING HALTÉROPHILIE

INSTRUCTIONS

TOOL KIT / FOURNITURES

DMC RETORS MAT SOFT COTTON ART. 89

TAPESTRY NEEDLE / AIGUILLE TAPISSERIE

12 COUNT (4.6 PTS/CM) MONO BLANK TAPESTRY NEEDLEPOINT CANVAS / CANEVAS MONO BLANK

















SCISSORS / CISEAUX

TRANSFER PEN (OPTIONAL) / STYLO TRANSFERT (EN OPTION)

ACRYLIC PAINT (OPTIONAL) / PEINTURE ACRYLIQUE (EN OPTION)

DESIGN SIZE / DIMENSIONS DESSIN 15 X 21 CM / 5,90" X 8,26"

COLOUR / COULEURS

SYMBOL SYMBOLE	COLOUR COULEUR	N° SKEINS* N° D'ÉCHEVETTES*	SYMBOL SYMBOLE	COLOUR COULEUR	N° SKEINS* N° D'ÉCHEVETTES*
					
	2746	x2		2126	x1
	2673	x1		2929	x2
					
	2170	x1		2310	x1
					
	2125	x1		2468	x1
					

STITCHES / POINTS

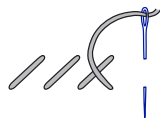

Half point / Demi point

* Based on stitching with the number of strands shown above, onto 12ct. / * Basé sur le nombre de brins préconisé au-dessus, sur 4.6pts/cm.

IMAGE TRANSFER / TRANSFERT D'IMAGES

You can also draw or paint this design onto your blank needlepoint canvas using the illustration provided, a transfer pen and acrylic paints.

- Trace your design onto your canvas using a fabric pen or a disappearing ink pen. Taping your needlepoint canvas to the design can help keep it in place.
- Optional: Following the outline you traced, colour in each section using your acrylic paint. Each intersection of the threads on your needlepoint canvas is where you will create a stitch, so make sure to designate each intersection a specific colour.

Top tip: you can use a toothpick, to unclog the needlepoint canvas if the holes become clogged up whilst painting.

Vous pouvez aussi peindre ce motif sur votre toile à canevas vierge à l'aide de l'image fournie et de peinture acrylique.

- Vous allez d'abord dessiner votre motif sur votre toile à canevas avec un crayon à tissu ou un stylo à encre effaçable. Coller votre toile sur l'image peut aider à la maintenir en place.
- En Option: En suivant les contours que vous avez tracés, coloriez chaque partie à l'aide de votre peinture acrylique. Chaque intersection de fils sur votre toile à canevas est l'endroit où vous ferez un point, alors faites attention à marquer chacune d'une couleur spécifique.

Astuce : vous pouvez utiliser un cure-dents pour déboucher les trous de la toile à canevas s'ils s'obstruent pendant que vous peignez.